

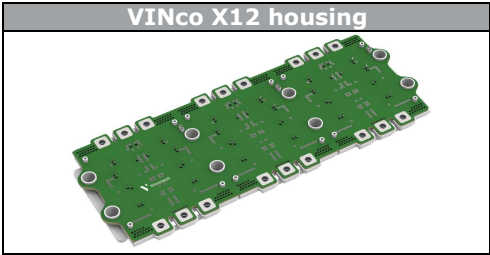
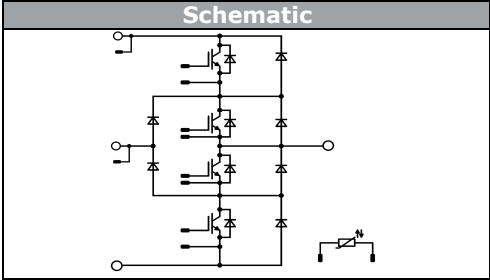

Vincotech

VINcoNPC X12	2400 V / 1200 A
<div style="border: 1px solid black; padding: 5px; margin-bottom: 5px;"> <p style="text-align: center; background-color: #ccc; margin: 0;"><b>Features</b></p> <ul style="list-style-type: none"> <li>2400V NPC-topology</li> <li>Low inductive</li> <li>High power screw interface</li> </ul> </div> <div style="border: 1px solid black; padding: 5px; margin-bottom: 5px;"> <p style="text-align: center; background-color: #ccc; margin: 0;"><b>Target Applications</b></p> <ul style="list-style-type: none"> <li>Solar inverter</li> <li>Wind Power</li> <li>Motor Drive</li> </ul> </div> <div style="border: 1px solid black; padding: 5px;"> <p style="text-align: center; background-color: #ccc; margin: 0;"><b>Types</b></p> <ul style="list-style-type: none"> <li>70-W624N3A1K2SC-L400FP</li> </ul> </div>	<div style="border: 1px solid black; padding: 5px; margin-bottom: 5px;"> <p style="text-align: center; background-color: #ccc; margin: 0;"><b>VINco X12 housing</b></p>  </div> <div style="border: 1px solid black; padding: 5px;"> <p style="text-align: center; background-color: #ccc; margin: 0;"><b>Schematic</b></p>  </div>

## Maximum Ratings

$T_j = 25\text{ °C}$ , unless otherwise specified

Parameter	Symbol	Condition	Value	Unit
<b>Buck Switch</b>				
Collector-emitter break down voltage	$V_{CE}$		1200	V
DC collector current	$I_C$	$T_j = T_{jmax}$ $T_s = 80\text{ °C}$	940	A
Pulsed collector current	$I_{CRM}$	$t_p$ limited by $T_{jmax}$	3600	A
Turn off safe operating area		$V_{CE} \leq 1200V, T_j \leq T_{op, max}$	2400	A
Power dissipation	$P_{tot}$	$T_j = T_{jmax}$ $T_s = 80\text{ °C}$	2470	W
Gate-emitter peak voltage	$V_{GE}$		±20	V
Short circuit ratings	$t_{SC}$ $V_{CC}$	$T_j \leq 150\text{ °C}$ $V_{GE} = 15\text{ V}$	10 800	µs V
Maximum Junction Temperature	$T_{jmax}$		175	°C

**Maximum Ratings** $T_j = 25\text{ °C}$ , unless otherwise specified

Parameter	Symbol	Condition	Value	Unit
-----------	--------	-----------	-------	------

**Buck Diode**

Peak Repetitive Reverse Voltage	$V_{RRM}$		1200	V
DC forward current	$I_F$	$T_j = T_{jmax}$ $T_s = 80\text{ °C}$	744	A
Repetitive peak forward current	$I_{FRM}$	$t_p = 10\text{ms}$ , sin 180°	2400	A
Power dissipation	$P_{tot}$	$T_j = T_{jmax}$ $T_s = 80\text{ °C}$	1490	W
Maximum Junction Temperature	$T_{jmax}$		175	°C

**Boost Switch**

Collector-emitter break down voltage	$V_{CE}$		1200	V
DC collector current	$I_C$	$T_j = T_{jmax}$ $T_s = 80\text{ °C}$	922	A
Pulsed collector current	$I_{CRM}$	$t_p$ limited by $T_{jmax}$	3600	A
Turn off safe operating area		$V_{CE} \leq 1200\text{V}$ , $T_j \leq T_{op\ max}$	2400	A
Power dissipation	$P_{tot}$	$T_j = T_{jmax}$ $T_s = 80\text{ °C}$	2192	W
Gate-emitter peak voltage	$V_{GE}$		±20	V
Short circuit ratings	$t_{SC}$ $V_{CC}$	$T_j \leq 150\text{ °C}$ $V_{GE} = 15\text{ V}$	10 800	µs V
Maximum Junction Temperature	$T_{jmax}$		175	°C

**Boost Inverse Diode**

Peak Repetitive Reverse Voltage	$V_{RRM}$		1200	V
DC forward current	$I_F$	$T_j = T_{jmax}$ $T_s = 80\text{ °C}$	634	A
Repetitive peak forward current	$I_{FRM}$	$t_p$ limited by $T_{jmax}$	1800	A
Power dissipation	$P_{tot}$	$T_j = T_{jmax}$ $T_s = 80\text{ °C}$	1069	W
Maximum Junction Temperature	$T_{jmax}$		175	°C

**Boost Diode**

Peak Repetitive Reverse Voltage	$V_{RRM}$		1200	V
DC forward current	$I_F$	$T_j = T_{jmax}$ $T_s = 80\text{ °C}$	648	A
Repetitive peak forward current	$I_{FRM}$	$t_p$ limited by $T_{jmax}$	1800	A
Power dissipation	$P_{tot}$	$T_j = T_{jmax}$ $T_s = 80\text{ °C}$	1069	W
Maximum Junction Temperature	$T_{jmax}$		175	°C



## Maximum Ratings

$T_i = 25\text{ °C}$ , unless otherwise specified

Parameter	Symbol	Condition	Value	Unit
-----------	--------	-----------	-------	------

### Module Properties

#### Thermal Properties

Storage temperature	$T_{stg}$		-40...+125	°C
Operation temperature under switching condition	$T_{op}$		-40...+( $T_{jmax} - 25$ )	°C
Maximum allowed PCB temperature	$T_{PCB}$		125	°C

#### Insulation Properties

Insulation voltage	$V_{isol}$	$t = 2\text{ s}$ DC Test Voltage*	4000	V
		$t = 1\text{ min}$ AC Voltage	2500	V
Creepage distance			min 12,7	mm
Clearance			min 12,7	mm
Competative Tracking Index	CTI		>200	

\* 100 % Tested in production



### Characteristic Values

Parameter	Symbol	Conditions					Value			Unit
		$V_{GE} [V]$ $V_{GS} [V]$	$V_{CE} [V]$ $V_{DS} [V]$	$V_{CE} [V]$ $V_{DS} [V]$	$I_C [A]$ $I_F [A]$ $I_D [A]$	$T_j [°C]$	Min	Typ	Max	
<b>Buck Switch</b>										
Gate emitter threshold voltage	$V_{GE(th)}$	$V_{CE} = V_{GE}$			0,0408	25	5,2	5,8	6,4	V
Collector-emitter saturation voltage	$V_{CE(sat)}$		15		1200	25 125	1,7	2,37 2,78	2,4	V
Collector-emitter cut-off current incl. Diode	$I_{CES}$		0	1200		25			0,024	mA
Gate-emitter leakage current	$I_{GES}$		20	0		25			2880	nA
Integrated Gate resistor	$R_{gint}$							0,166667		$\Omega$
Turn-on delay time	$t_{d(on)}$	$R_{goff} = 0,42 \Omega$ $R_{gon} = 0,42 \Omega$	-10/+15	600	1200	25		113		ns
Rise time	$t_r$					125		43		
Turn-off delay time	$t_{d(off)}$					25		183		
Fall time	$t_f$					125		229		
Turn-on energy loss per pulse	$E_{on}$					25		44,08		
Turn-off energy loss per pulse	$E_{off}$					125		48,91		
Input capacitance	$C_{ies}$							66480		pF
Output capacitance	$C_{oss}$	$f = 1 \text{ MHz}$	0	25	25			4560		
Reverse transfer capacitance	$C_{rss}$							3840		
Gate charge	$Q_G$		$\pm 15$	960	960	25		9120		nC
Thermal resistance chip to heatsink	$R_{th(j-s)}$	phase-change material $\lambda = 3,4 \text{ W/mK}$						0,038		K/W
<b>Buck Diode</b>										
Diode forward voltage	$V_F$				1200	25 125		2,34 2,38	2,52	V
Reverse leakage current	$I_R$			1200		25			1440	$\mu\text{A}$
Peak reverse recovery current	$I_{RRM}$	$R_{goff} = 0,42 \Omega$	-10/+15	600	1200	25		1075		A
Reverse recovery time	$t_{rr}$					125		1355		
Reverse recovered charge	$Q_{rr}$					25		169		
Peak rate of fall of recovery current	$(di_{rr}/dt)_{max}$					125		214		
Reverse recovered energy	$E_{rec}$					25		73,24		
						125		136,71		
Thermal resistance chip to heatsink	$R_{th(j-s)}$	phase-change material $\lambda = 3,4 \text{ W/mK}$						0,06		K/W



### Characteristic Values

Parameter	Symbol	Conditions					Value			Unit
		$V_{GE} [V]$ $V_{GS} [V]$	$V_{CE} [V]$ $V_{DS} [V]$	$V_F [V]$ $V_{CE} [V]$ $V_{DS} [V]$	$I_C [A]$ $I_F [A]$ $I_D [A]$	$T_j [°C]$	Min	Typ	Max	

#### Boost Switch

Gate emitter threshold voltage	$V_{GE(th)}$	$V_{CE} = V_{CE}$			0,0456	25	5	5,80	6,5	V
Collector-emitter saturation voltage	$V_{CESat}$		15		1200	25 125		1,91 2,14	2,05	V
Collector-emitter cut-off incl diode	$I_{CES}$		0	1200		25			0,0156	mA
Gate-emitter leakage current	$I_{GES}$		20	0		25			1440	nA
Integrated Gate resistor	$R_{gint}$					25		0,625		$\Omega$
Turn-on delay time	$t_{d(on)}$	$R_{gon} = 0,42 \Omega$ $R_{goff} = 0,42 \Omega$	-10/+15	600	1200	25 125		158		ns
Rise time	$t_r$							64		
Turn-off delay time	$t_{d(off)}$							273		
Fall time	$t_f$							57		
Turn-on energy loss per pulse	$E_{on}$							84,6		
Turn-off energy loss per pulse	$E_{off}$							68,3		
Input capacitance	$C_{ies}$							73800		
Output capacitance	$C_{oss}$							4860		
Reverse transfer capacitance	$C_{rss}$							4140		
Gate charge	$Q_G$							15		
Thermal resistance chip to heatsink	$R_{th(j-s)}$	phase-change material $\lambda = 3,4 \text{ W/mK}$						0,04		K/W

#### Boost Inverse Diode

Diode forward voltage	$V_F$				900	25 125	1,35	1,90 1,84	2,05	V
Reverse leakage current	$I_R$					25			168	$\mu A$
Thermal resistance chip to heatsink	$R_{th(j-s)}$	phase-change material $\lambda = 3,4 \text{ W/mK}$						0,09		K/W

#### Boost Diode

Diode forward voltage	$V_F$				900	25 125	1,35	1,90 1,84	2,05	V
Reverse leakage current	$I_r$			1200		25			168	$\mu A$
Peak reverse recovery current	$I_{RRM}$	$R_{gon} = 0,42 \Omega$ $R_{goff} = 0,42 \Omega$	-10/+15	600	1200	25 125		696		A
Reverse recovery time	$t_{rr}$							296		
Reverse recovered charge	$Q_{rr}$							451		
Peak rate of fall of recovery current	$(di_{rr}/dt)_{max}$							89		
Reverse recovery energy	$E_{rec}$							173		
								5538		
		4822								
		31,66								
		69,81								
Thermal resistance chip to heatsink	$R_{th(j-s)}$	phase-change material $\lambda = 3,4 \text{ W/mK}$						0,09		K/W



Vincotech

### Characteristic Values

Parameter	Symbol	Conditions					Value			Unit				
		$V_{GE}$ [V]	$V_{CE}$ [V]	$V_{DS}$ [V]	$V_F$ [V]	$V_{CE}$ [V]	$V_{DS}$ [V]	$I_C$ [A]	$I_F$ [A]		$I_D$ [A]	$T_j$ [°C]	Min	Typ
<b>Thermistor</b>														
Rated resistance	$R$									25		22000		$\Omega$
Deviation of $R_{100}$	$\Delta_{R/R}$	$R_{100} = 1484 \Omega$								100	-5		+5	%
Power dissipation	$P$									25		5		mW
Power dissipation constant										25		1,5		mW/K
B-value	$B_{(25/50)}$	Tol. $\pm 1\%$								25		3962		K
B-value	$B_{(25/100)}$	Tol. $\pm 1\%$								25		4000		K
Vincotech NTC Reference													I	
<b>Module Properties</b>														
Module inductance (from chips to PCB)	$L_{sCE}$ C-PCB	Buck Boost										5 9		nH
Weight	$m$												1930	g



# Buck

## Buck IGBT and Buck FWD

**figure 1.** IGBT

Typical output characteristics

$I_C = f(V_{CE})$

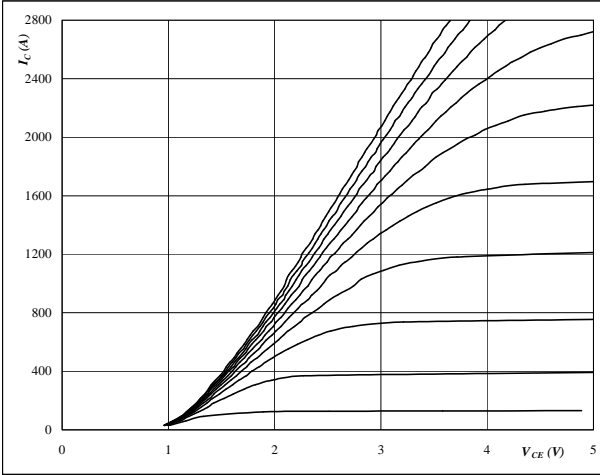

**At**

$t_p = 350 \mu s$   
 $T_j = 25 \text{ }^\circ C$   
 $V_{GE}$  from 7 V to 17 V in steps of 1 V

**figure 2.** IGBT

Typical output characteristics

$I_C = f(V_{CE})$

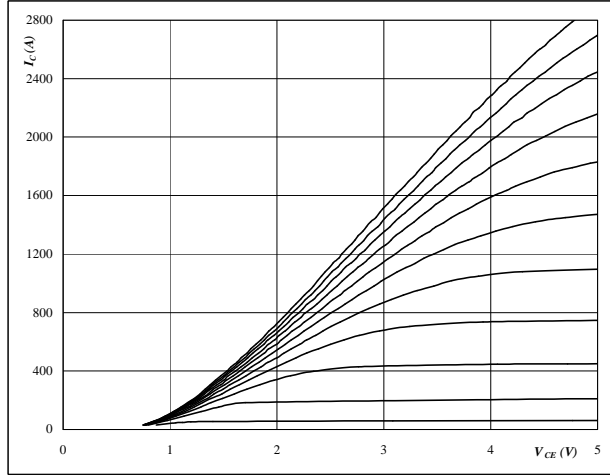

**At**

$t_p = 350 \mu s$   
 $T_j = 125 \text{ }^\circ C$   
 $V_{GE}$  from 7 V to 17 V in steps of 1 V

**figure 3.** IGBT

Typical transfer characteristics

$I_C = f(V_{GE})$

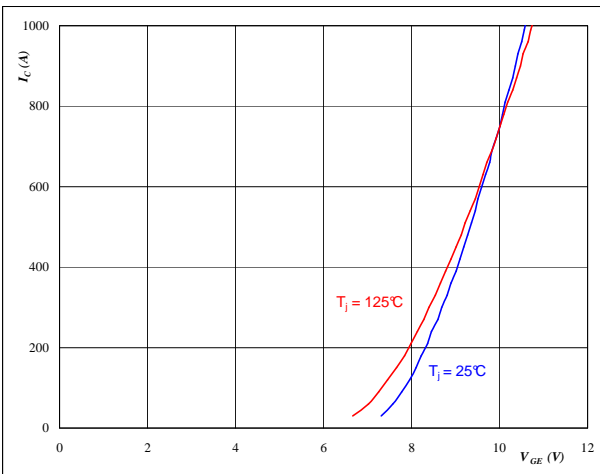

**At**

$t_p = 350 \mu s$   
 $V_{CE} = 10 V$

**figure 4.** FWD

Typical FWD forward current as a function of forward voltage

$I_F = f(V_F)$

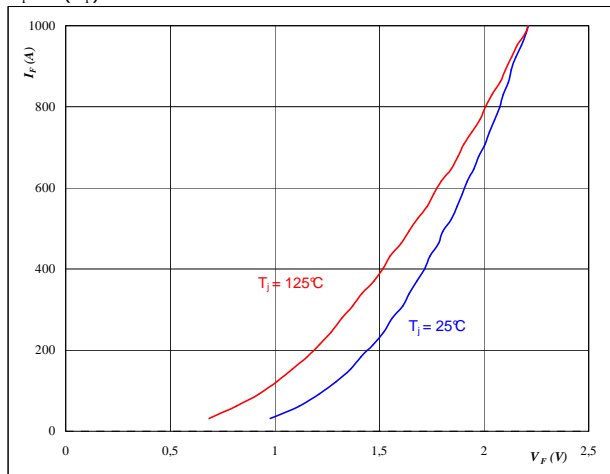

**At**

$t_p = 350 \mu s$



# Buck

## Buck IGBT and Buck FWD

**figure 5. IGBT**

**Typical switching energy losses as a function of collector current**

$E = f(I_C)$

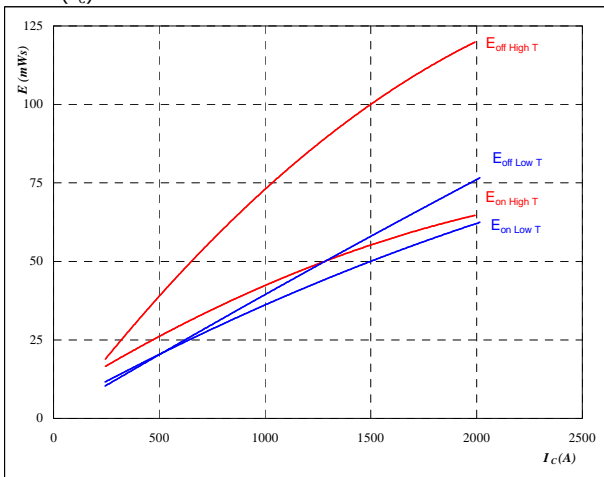

With an inductive load at

- $T_j = 25/125 \text{ } ^\circ\text{C}$
- $V_{CE} = 600 \text{ V}$
- $V_{GE} = -10/+15 \text{ V}$
- $R_{gon} = 0,42 \text{ } \Omega$
- $R_{goff} = 0,42 \text{ } \Omega$

**figure 6. FWD**

**Typical reverse recovery energy loss as a function of collector current**

$E_{rec} = f(I_C)$

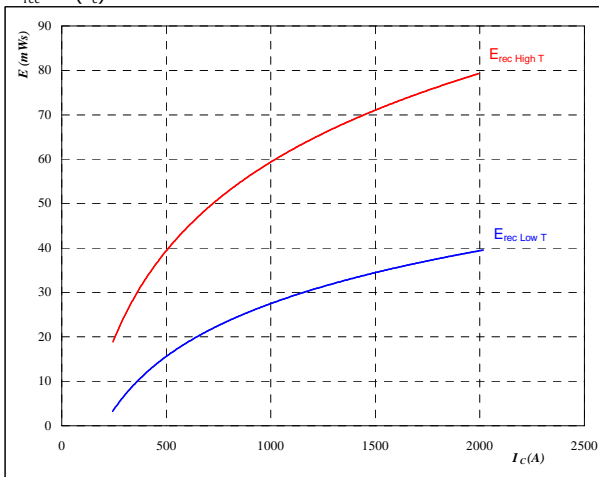

With an inductive load at

- $T_j = 25/125 \text{ } ^\circ\text{C}$
- $V_{CE} = 600 \text{ V}$
- $V_{GE} = -10/+15 \text{ V}$
- $R_{gon} = 0,42 \text{ } \Omega$

**figure 7. IGBT**

**Typical switching times as a function of collector current**

$t = f(I_C)$

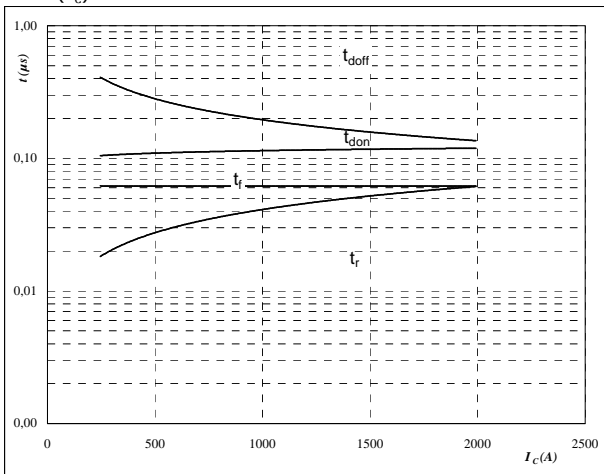

With an inductive load at

- $T_j = 125 \text{ } ^\circ\text{C}$
- $V_{CE} = 600 \text{ V}$
- $V_{GE} = -10/+15 \text{ V}$
- $R_{gon} = 0,42 \text{ } \Omega$
- $R_{goff} = 0,42 \text{ } \Omega$

**figure 8. FWD**

**Typical reverse recovery time as a function of collector current**

$t_{rr} = f(I_C)$

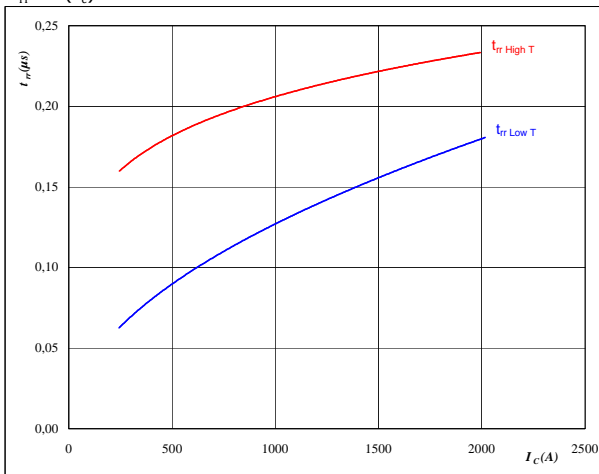

**At**

- $T_j = 25/125 \text{ } ^\circ\text{C}$
- $V_{CE} = 600 \text{ V}$
- $V_{GE} = -10/+15 \text{ V}$
- $R_{gon} = 0,42 \text{ } \Omega$





# Buck

## Buck IGBT and Buck FWD

**figure 9.** FWD

Typical reverse recovery charge as a function of collector current

$$Q_{rr} = f(I_C)$$

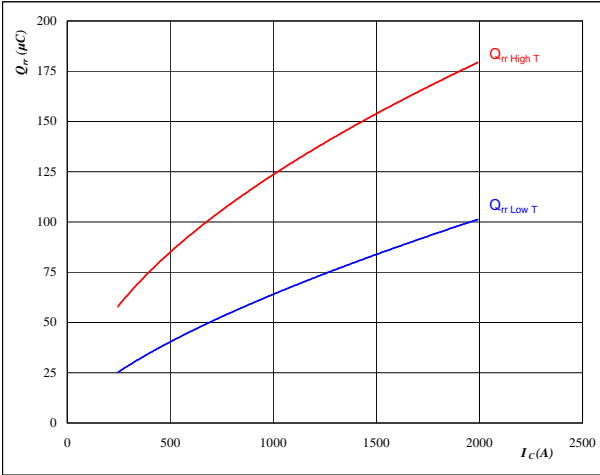

At

- $T_j = 25/125$  °C
- $V_{CE} = 600$  V
- $V_{GE} = -10/+15$  V
- $R_{gon} = 0,42$   $\Omega$

**figure 10.** FWD

Typical reverse recovery current as a function of collector current

$$I_{RRM} = f(I_C)$$

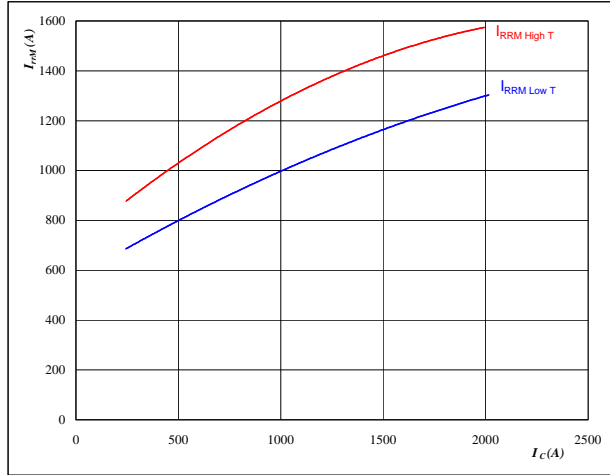

At

- $T_j = 25/125$  °C
- $V_{CE} = 600$  V
- $V_{GE} = -10/+15$  V
- $R_{gon} = 0,42$   $\Omega$

**figure 11.** FWD

Typical rate of fall of forward and reverse recovery current as a function of collector current

$$dI_{f0}/dt, dI_{rec}/dt = f(I_C)$$

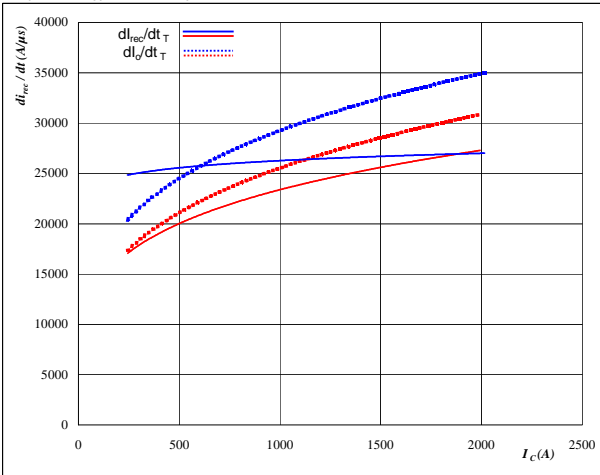

At

- $T_j = 25/125$  °C
- $V_{CE} = 600$  V
- $V_{GE} = -10/+15$  V
- $R_{gon} = 0,42$   $\Omega$



# Buck

## Buck IGBT and Buck FWD

**figure 12. IGBT**

**IGBT transient thermal impedance as a function of pulse width**

$$Z_{th(j-s)} = f(t_p)$$

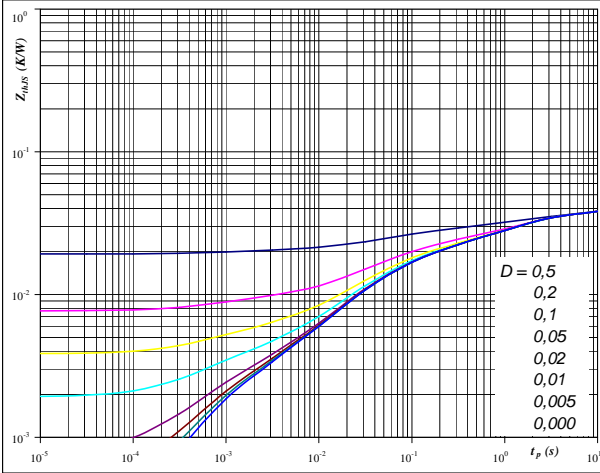

**At**

$$D = t_p / T$$

IGBT thermal model values with phase-change material

$$R_{th(j-s)} = 0,038 \text{ K/W}$$

IGBT thermal model values

With phase change material

R (K/W)	Tau (s)
1,56E-02	2,31E+00
6,86E-03	3,15E-01
8,33E-03	6,36E-02
5,40E-03	1,92E-02
1,08E-03	2,08E-03
1,24E-03	5,82E-04

**figure 13. FWD**

**FWD transient thermal impedance as a function of pulse width**

$$Z_{th(j-s)} = f(t_p)$$

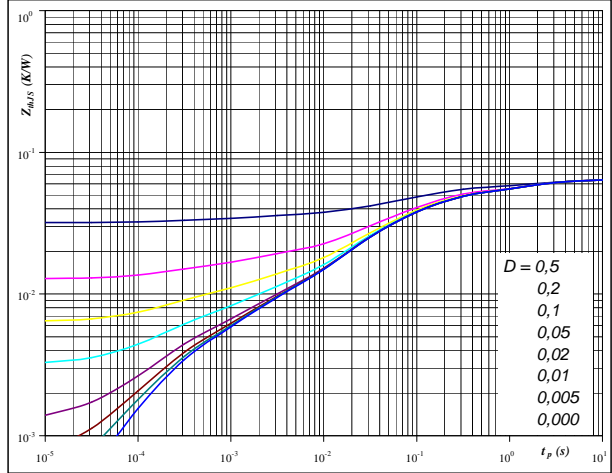

**At**

$$D = t_p / T$$

FWD thermal model values with phase-change material

$$R_{th(j-s)} = 0,064 \text{ K/W}$$

FWD thermal model values

With phase change material

R (K/W)	Tau (s)
1,54E-02	1,70E+00
2,39E-02	1,27E-01
1,70E-02	2,50E-02
4,58E-03	1,61E-03
2,91E-03	1,90E-04

**figure 14. IGBT**

**Power dissipation as a function of heatsink temperature**

$$P_{tot} = f(T_s)$$

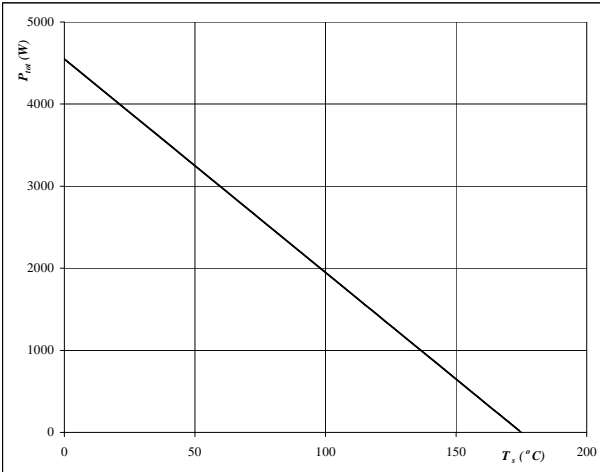

**At**

$$T_j = 175 \text{ °C}$$

**figure 15. IGBT**

**Collector current as a function of heatsink temperature**

$$I_C = f(T_s)$$

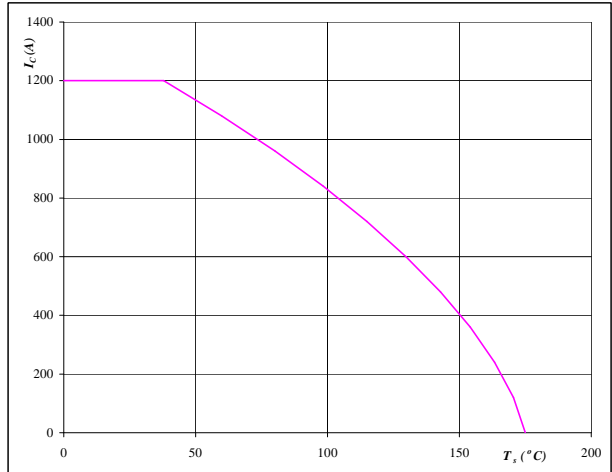

**At**

$$T_j = 175 \text{ °C}$$

$$V_{GE} = 15 \text{ V}$$



# Buck

## Buck IGBT and Buck FWD

**figure 16.** FWD

**Power dissipation as a function of heatsink temperature**

$P_{tot} = f(T_s)$

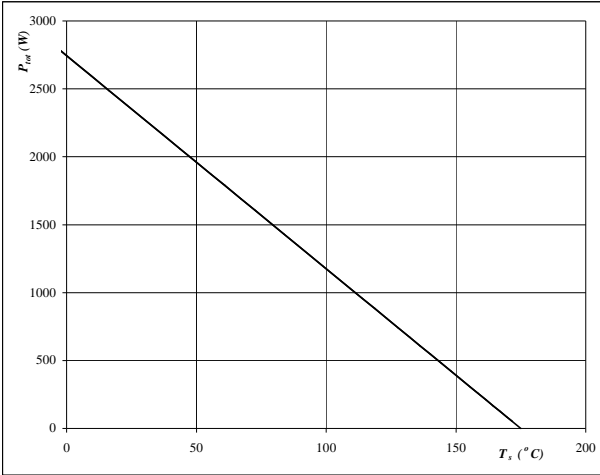

**At**  
 $T_j = 175$  °C

**figure 17.** FWD

**Forward current as a function of heatsink temperature**

$I_F = f(T_s)$

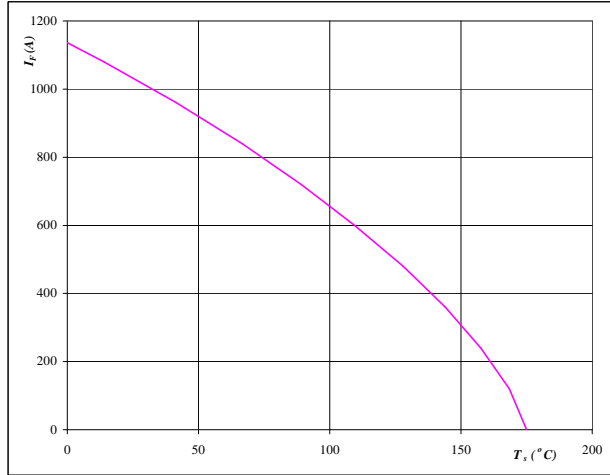

**At**  
 $T_j = 175$  °C

**figure 18.** IGBT

**Safe operating area as a function of collector-emitter voltage**

$I_C = f(V_{CE})$

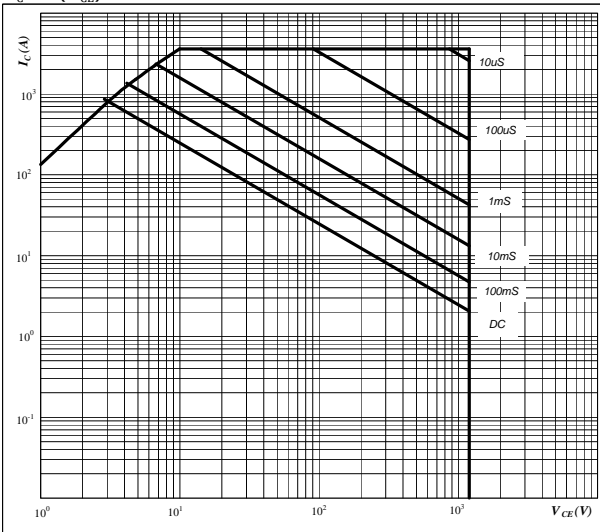

**At**  
 $D =$  single pulse       $V_{GE} = 15$  V  
 $T_s = 80$  °C       $T_j = T_{jmax}$



# Buck

## Buck IGBT and Buck FWD

**figure 20.** IGBT  
**Reverse bias safe operating area**

$$I_C = f(V_{CE})$$

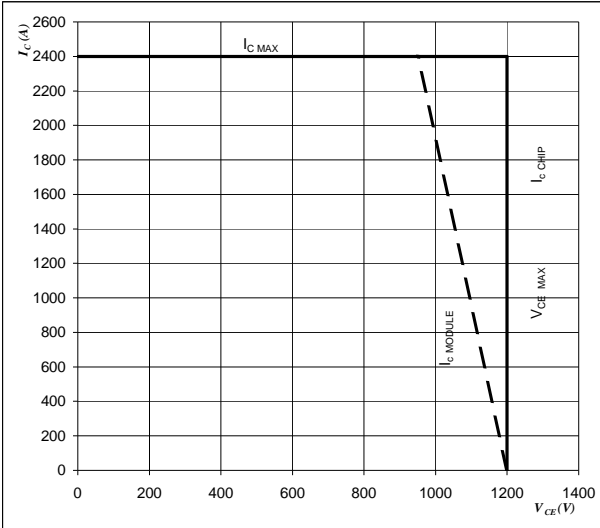

**At**

$$U_{ccminus} = U_{ccplus}$$

Switching mode : 3 level switching



# Boost

## Boost IGBT and Boost FWD

**figure 1. IGBT**

**Typical output characteristics**

$I_C = f(V_{CE})$

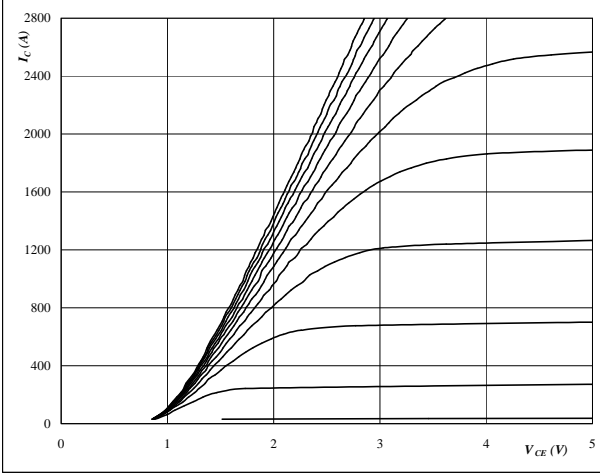

**At**

$t_p = 350 \mu s$   
 $T_j = 25 \text{ } ^\circ C$   
 $V_{GE}$  from 7 V to 17 V in steps of 1 V

**figure 2. IGBT**

**Typical output characteristics**

$I_C = f(V_{CE})$

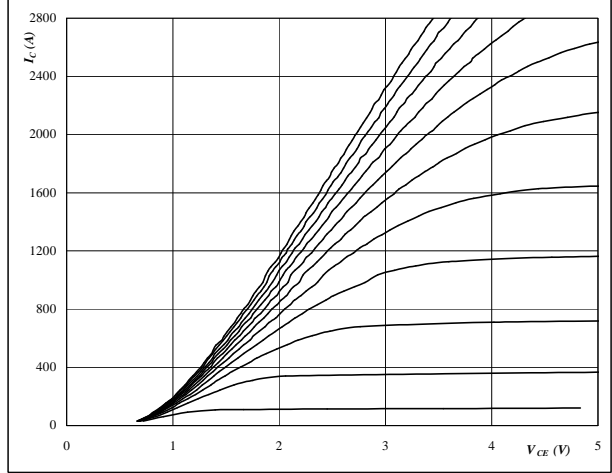

**At**

$t_p = 350 \mu s$   
 $T_j = 125 \text{ } ^\circ C$   
 $V_{GE}$  from 7 V to 17 V in steps of 1 V

**figure 3. IGBT**

**Typical transfer characteristics**

$I_C = f(V_{GE})$

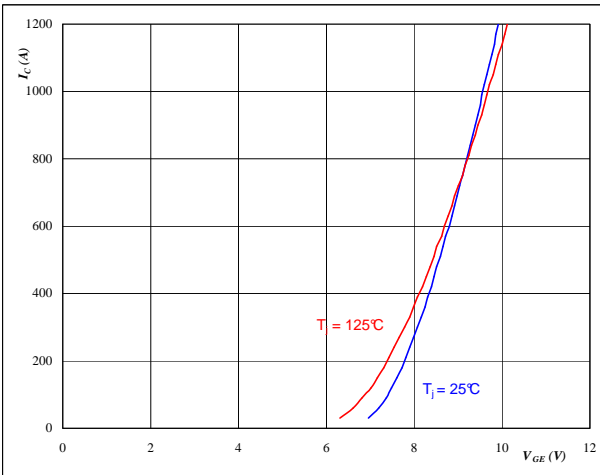

**At**

$t_p = 350 \mu s$   
 $V_{CE} = 10 V$

**figure 4. FWD**

**Typical FWD forward current as a function of forward voltage**

$I_F = f(V_F)$

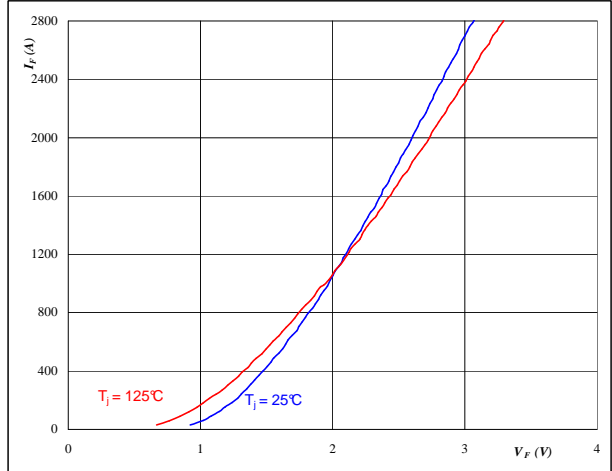

**At**

$t_p = 350 \mu s$



## Boost

### Boost IGBT and Boost FWD

**figure 5. IGBT**

**Typical switching energy losses as a function of collector current**

$$E = f(I_c)$$

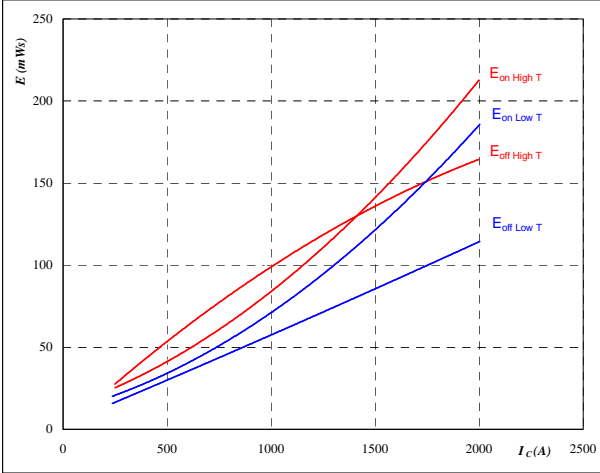

With an inductive load at

$T_j = 25/125 \text{ } ^\circ\text{C}$   
 $V_{CE} = 600 \text{ V}$   
 $V_{GE} = -10/ +15 \text{ V}$   
 $R_{gon} = 0,42 \text{ } \Omega$   
 $R_{goff} = 0,42 \text{ } \Omega$

**figure 6. FWD**

**Typical reverse recovery energy loss as a function of collector current**

$$E_{rec} = f(I_c)$$

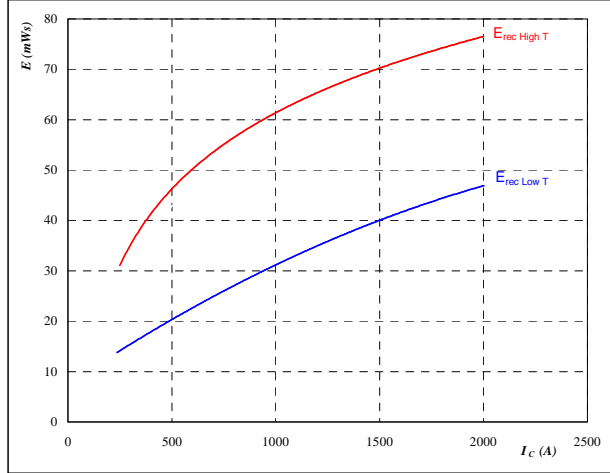

With an inductive load at

$T_j = 25/125 \text{ } ^\circ\text{C}$   
 $V_{CE} = 600 \text{ V}$   
 $V_{GE} = -10/ +15 \text{ V}$   
 $R_{gon} = 0,42 \text{ } \Omega$

**figure 7. IGBT**

**Typical switching times as a function of collector current**

$$t = f(I_c)$$

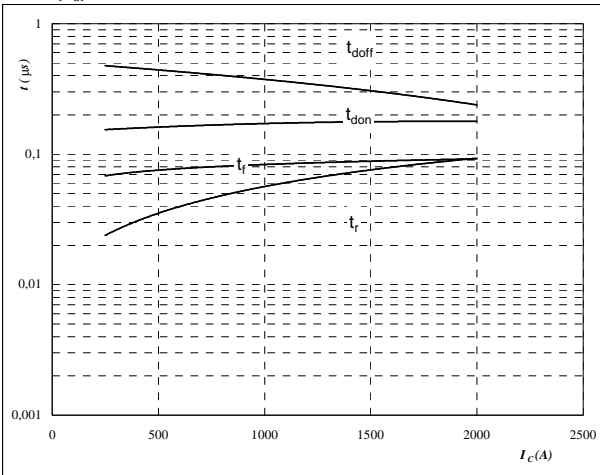

With an inductive load at

$T_j = 125 \text{ } ^\circ\text{C}$   
 $V_{CE} = 600 \text{ V}$   
 $V_{GE} = -10/ +15 \text{ V}$   
 $R_{gon} = 0,42 \text{ } \Omega$   
 $R_{goff} = 0,42 \text{ } \Omega$

**figure 8. FWD**

**Typical reverse recovery time as a function of collector current**

$$t_{rr} = f(I_c)$$

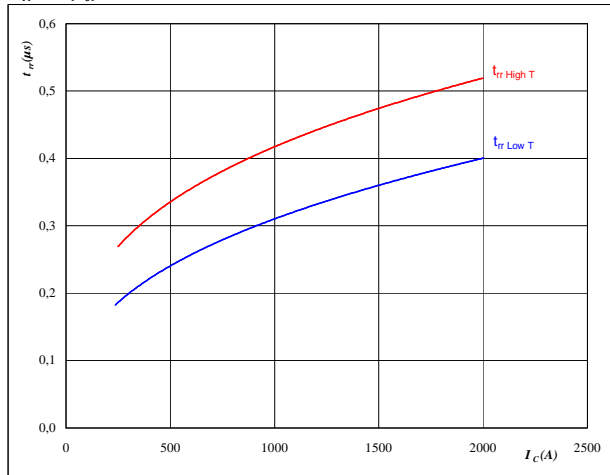

**At**

$T_j = 25/125 \text{ } ^\circ\text{C}$   
 $V_{CE} = 600 \text{ V}$   
 $V_{GE} = -10/ +15 \text{ V}$   
 $R_{gon} = 0,42 \text{ } \Omega$



# Boost

## Boost IGBT and Boost FWD

figure 9. FWD

Typical reverse recovery charge as a function of collector current

$$Q_{rr} = f(I_c)$$

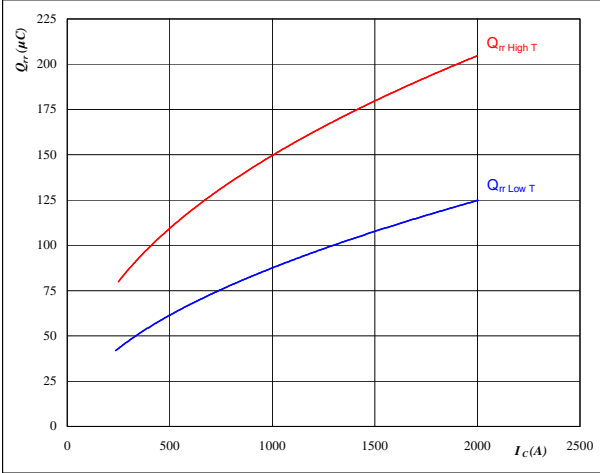

**At**  
 $T_j = 25/125$  °C  
 $V_{CE} = 600$  V  
 $V_{GE} = -10/ +15$  V  
 $R_{gon} = 0,42$  Ω

figure 10. FWD

Typical reverse recovery current as a function of collector current

$$I_{RRM} = f(I_c)$$

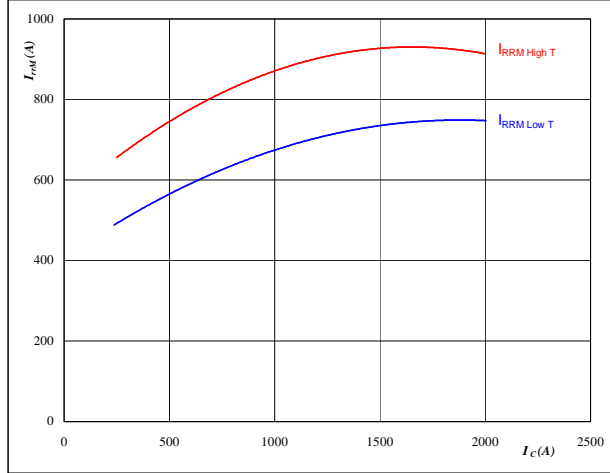

**At**  
 $T_j = 25/125$  °C  
 $V_{CE} = 600$  V  
 $V_{GE} = -10/ +15$  V  
 $R_{gon} = 0,42$  Ω

figure 11. FWD

Typical rate of fall of forward and reverse recovery current as a function of collector current

$$di_o/dt, di_{rec}/dt = f(I_c)$$

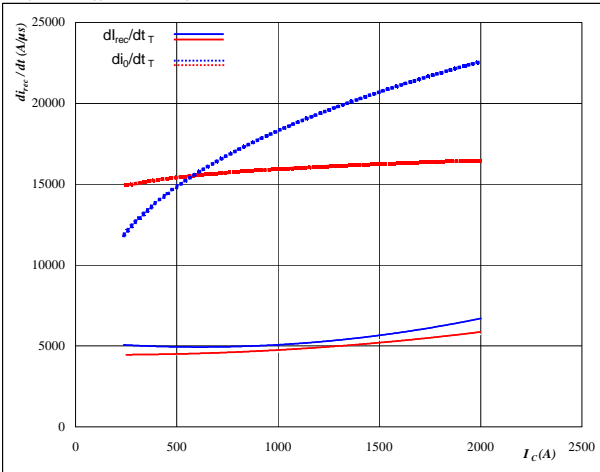

**At**  
 $T_j = 25/125$  °C  
 $V_{CE} = 600$  V  
 $V_{GE} = -10/ +15$  V  
 $R_{gon} = 0,4$  Ω



# Boost

## Boost IGBT and Boost FWD

**figure 12. IGBT**

**IGBT transient thermal impedance as a function of pulse width**

$$Z_{th(j-s)} = f(t_p)$$

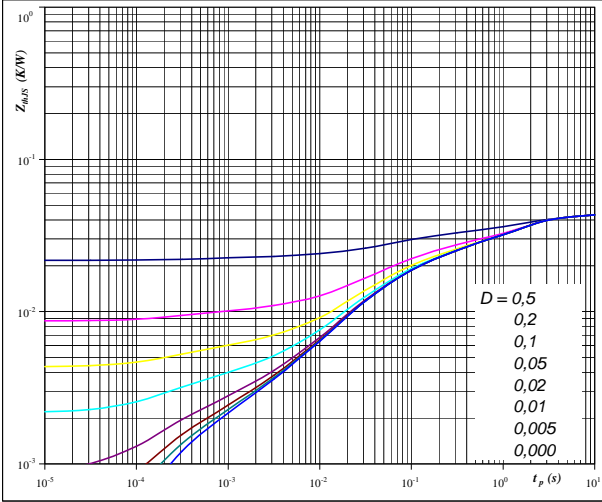

**At**

$$D = t_p / T$$

IGBT thermal model values with phase-change material

$$R_{th(j-s)} = 0,043 \text{ K/W}$$

IGBT thermal model values

With phase-change material

R (K/W)	Tau (s)
1,98E-02	1,78E+00
1,01E-02	1,66E-01
1,07E-02	3,06E-02
1,43E-03	2,59E-03
1,32E-03	2,69E-04

**figure 13. FWD**

**FWD transient thermal impedance as a function of pulse width**

$$Z_{th(j-s)} = f(t_p)$$

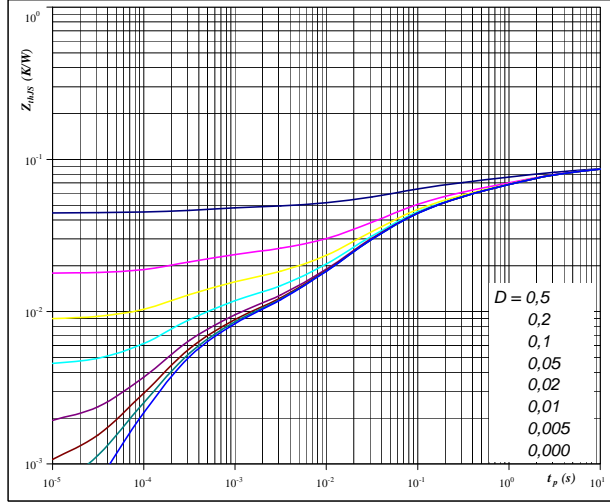

**At**

$$D = t_p / T$$

FWD thermal model values with phase-change material

$$R_{th(j-s)} = 0,089 \text{ K/W}$$

FWD thermal model values

With phase-change material

R (K/W)	Tau (s)
1,39E-02	5,78E+00
1,77E-02	1,38E+00
1,62E-02	2,57E-01
2,22E-02	5,31E-02
9,23E-03	1,60E-02
3,35E-03	2,27E-03
6,26E-03	2,74E-04

**figure 14. IGBT**

**Power dissipation as a function of heatsink temperature**

$$P_{tot} = f(T_s)$$

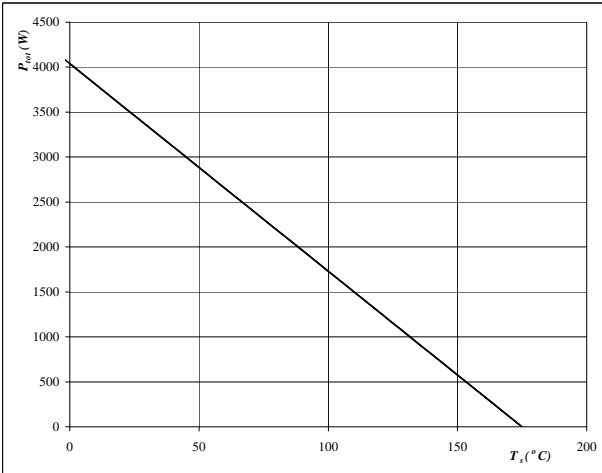

**At**

$$T_j = 175 \text{ °C}$$

**figure 15. IGBT**

**Collector current as a function of heatsink temperature**

$$I_C = f(T_s)$$

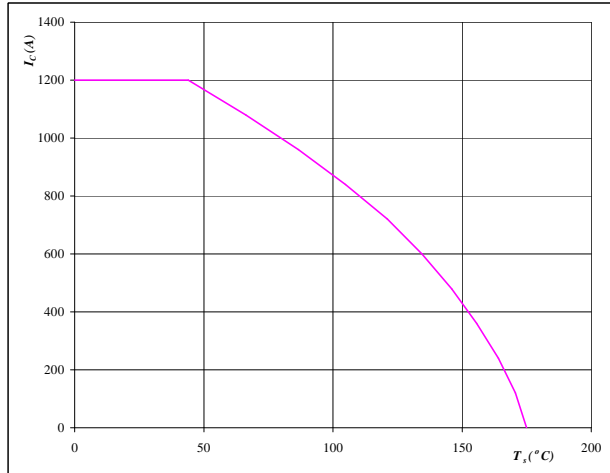

**At**

$$T_j = 175 \text{ °C}$$

$$V_{GE} = 15 \text{ V}$$





# Boost

## Boost IGBT and Boost FWD

**figure 16.** FWD

**Power dissipation as a function of heatsink temperature**

$$P_{tot} = f(T_s)$$

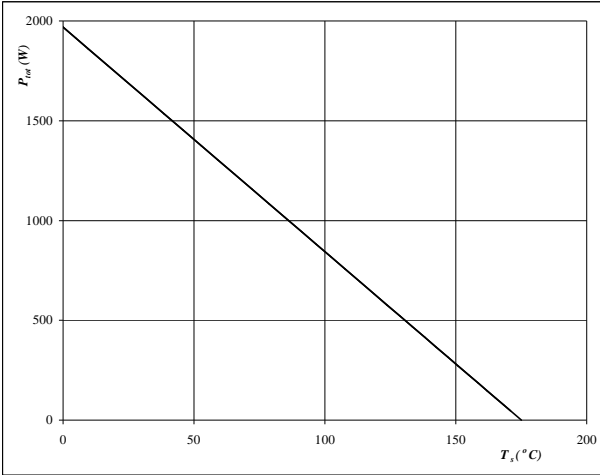

**At**  
 $T_j = 175 \text{ °C}$

**figure 17.** FWD

**Forward current as a function of heatsink temperature**

$$I_F = f(T_s)$$

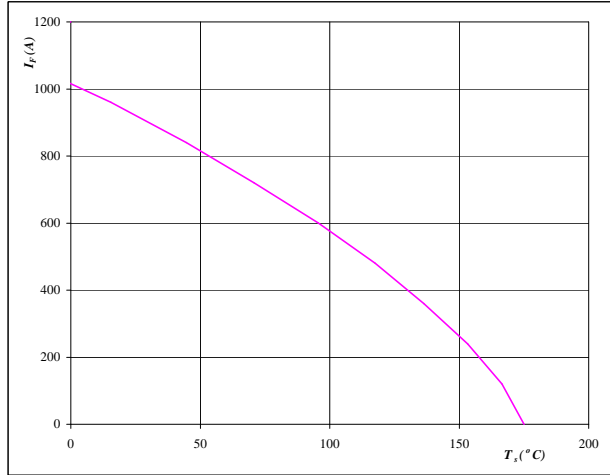

**At**  
 $T_j = 175 \text{ °C}$

**figure 18.** IGBT

**Reverse bias safe operating area**

$$I_C = f(V_{CE})$$

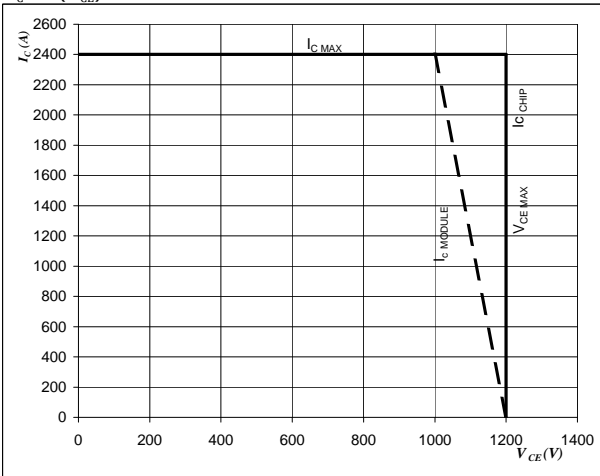

**At**  
 $U_{cminus} = U_{cplus}$   
Switching mode : 3 level switching



### Boost Inverse Diode

**figure 19. Boost Inverse Diode**

**Typical FWD forward current as a function of forward voltage**

$I_F = f(V_F)$

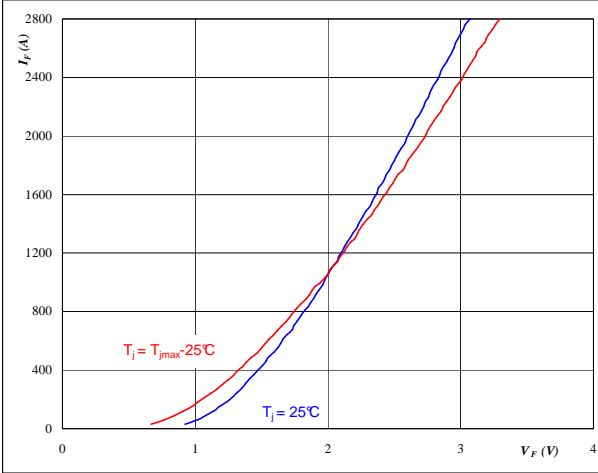

**At**  
 $t_p = 250 \mu s$

**figure 20. Boost Inverse Diode**

**FWD transient thermal impedance as a function of pulse width**

$Z_{th(j-s)} = f(t_p)$

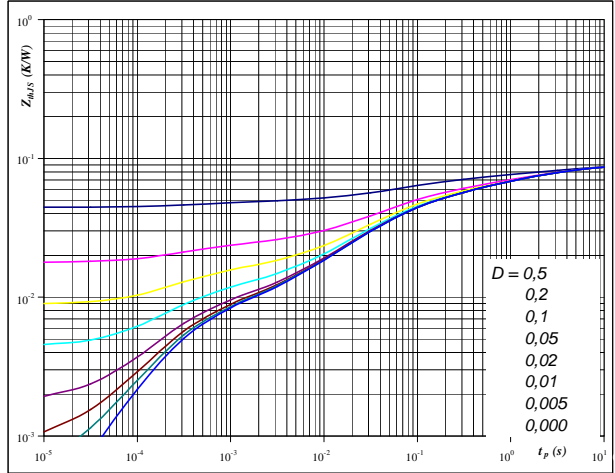

**At**  
 $D = t_p / T$   
 $R_{th(j-s)} = 0,09 \text{ K/W}$

**figure 21. Boost Inverse Diode**

**Power dissipation as a function of heatsink temperature**

$P_{tot} = f(T_s)$

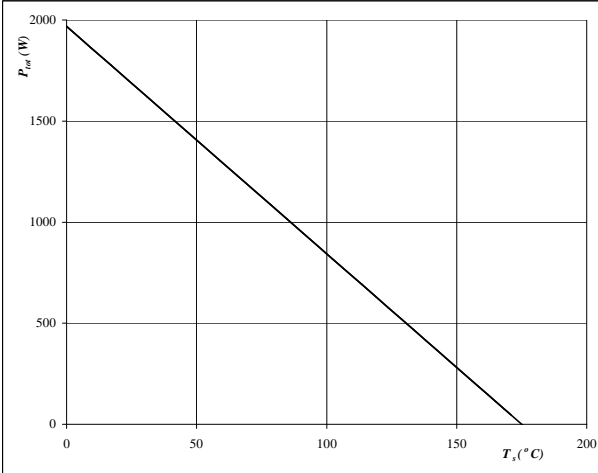

**At**  
 $T_j = 175 \text{ °C}$

**figure 22. Boost Inverse Diode**

**Forward current as a function of heatsink temperature**

$I_F = f(T_s)$

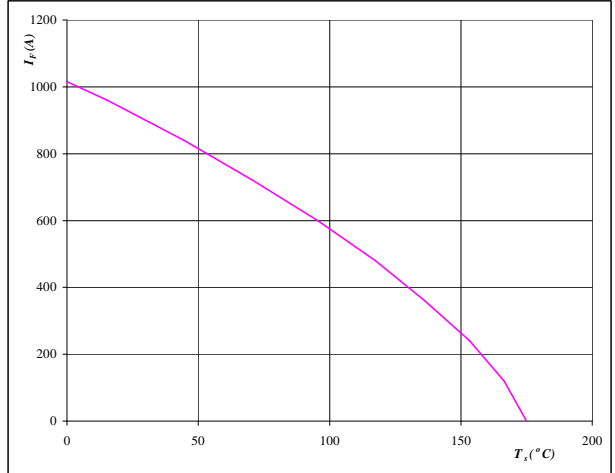

**At**  
 $T_j = 175 \text{ °C}$



# Thermistor

**figure 1. Thermistor**

**Typical NTC characteristic  
as a function of temperature**

$$R = f(T)$$

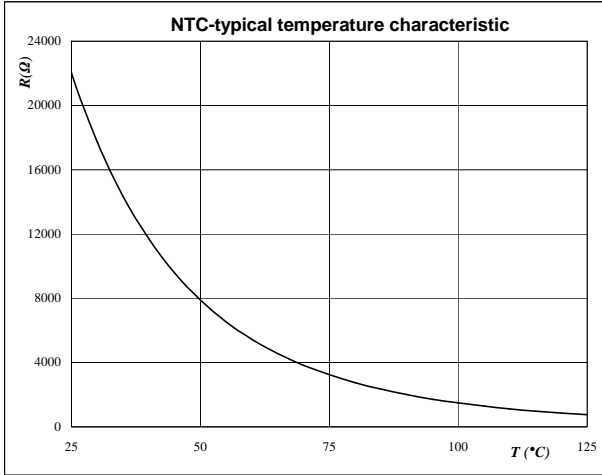



### Switching Definitions Buck

**General conditions**

$T_j$	=	125 °C
$R_{gon}$	=	0,42 Ω
$R_{goff}$	=	0,42 Ω

**figure 1. IGBT**

**Turn-off Switching Waveforms & definition of  $t_{doff}$   $t_{Eoff}$**   
( $t_{Eoff}$  = integrating time for  $E_{off}$ )

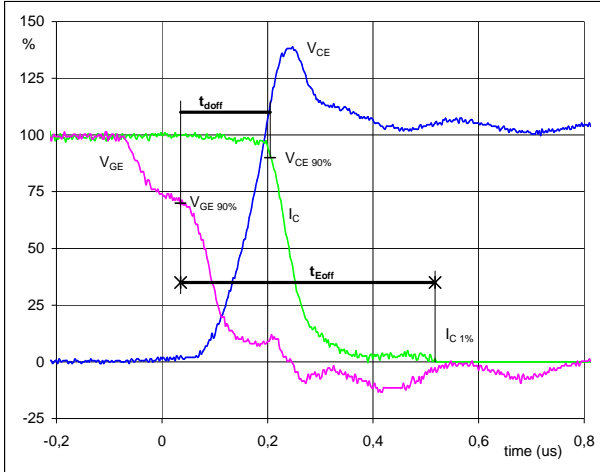

$V_{GE}$ (0%) =	-10	V
$V_{GE}$ (100%) =	15	V
$V_C$ (100%) =	600	V
$I_C$ (100%) =	1201	A
$t_{doff}$ =	0,23	μs
$t_{Eoff}$ =	0,48	μs

**figure 2. IGBT**

**Turn-on Switching Waveforms & definition of  $t_{don}$   $t_{Eon}$**   
( $t_{Eon}$  = integrating time for  $E_{on}$ )

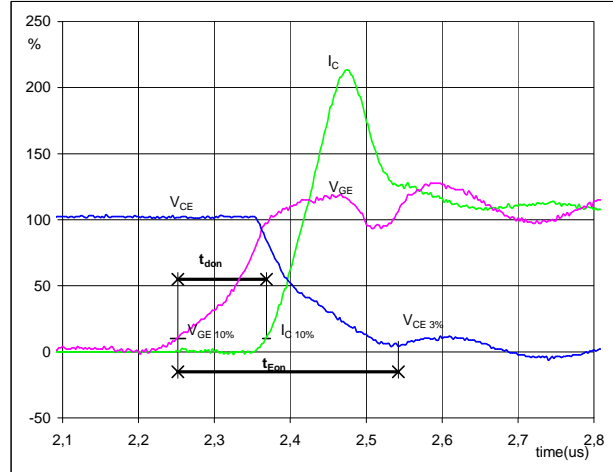

$V_{GE}$ (0%) =	-10	V
$V_{GE}$ (100%) =	15	V
$V_C$ (100%) =	600	V
$I_C$ (100%) =	1201	A
$t_{don}$ =	0,11	μs
$t_{Eon}$ =	0,29	μs

**figure 3. IGBT**

**Turn-off Switching Waveforms & definition of  $t_f$**

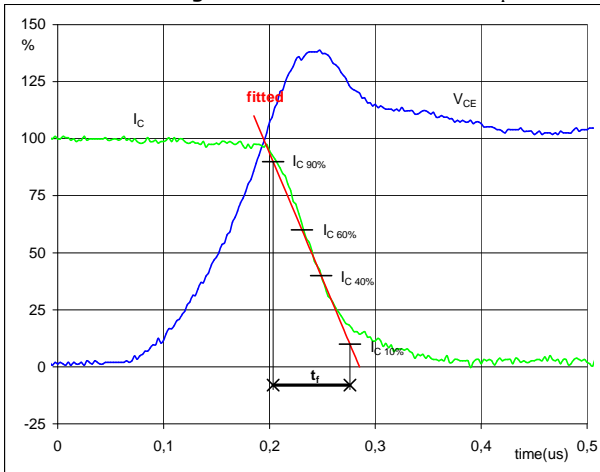

$V_C$ (100%) =	600	V
$I_C$ (100%) =	1201	A
$t_f$ =	0,07	μs

**figure 4. IGBT**

**Turn-on Switching Waveforms & definition of  $t_r$**

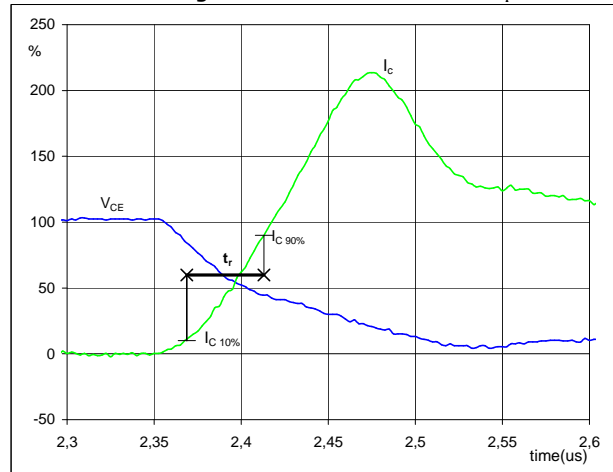

$V_C$ (100%) =	600	V
$I_C$ (100%) =	1201	A
$t_r$ =	0,04	μs



### Switching Definitions Buck

**figure 5. IGBT**  
**Turn-off Switching Waveforms & definition of  $t_{Eoff}$**

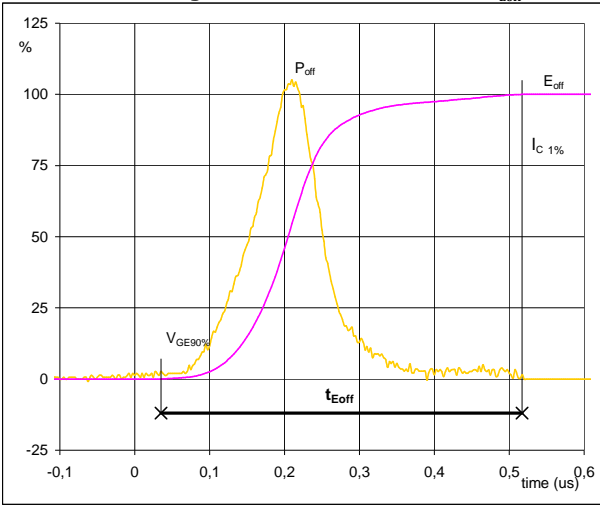

$P_{off} (100\%) = 720,80 \text{ kW}$   
 $E_{off} (100\%) = 86,78 \text{ mJ}$   
 $t_{Eoff} = 0,48 \text{ }\mu\text{s}$

**figure 6. IGBT**  
**Turn-on Switching Waveforms & definition of  $t_{Eon}$**

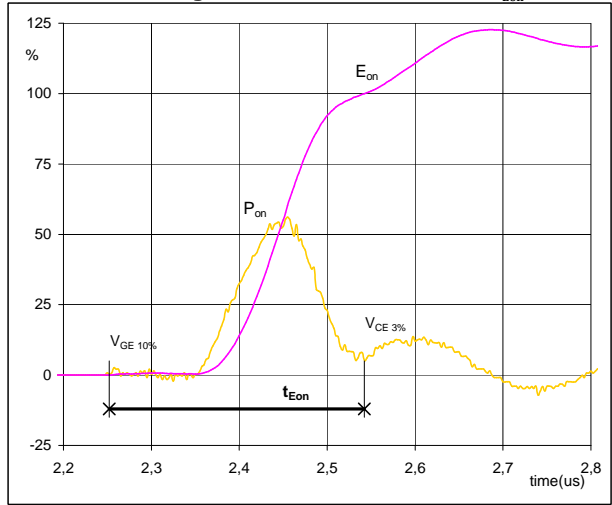

$P_{on} (100\%) = 720,80 \text{ kW}$   
 $E_{on} (100\%) = 48,91 \text{ mJ}$   
 $t_{Eon} = 0,29 \text{ }\mu\text{s}$

**figure 7. FWD**  
**Turn-off Switching Waveforms & definition of  $t_{tr}$**

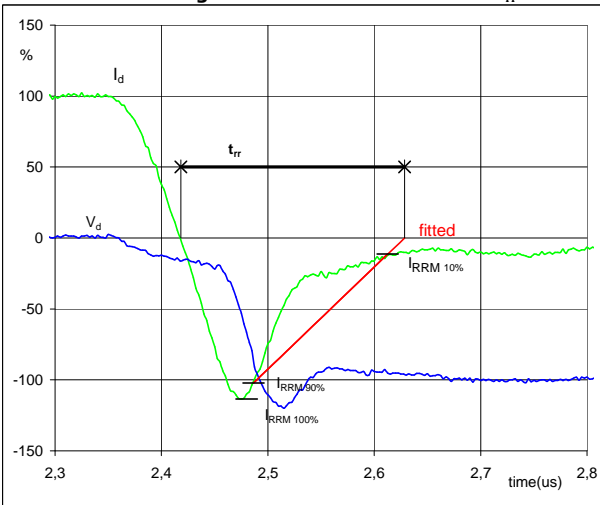

$V_d (100\%) = 600 \text{ V}$   
 $I_d (100\%) = 1201 \text{ A}$   
 $I_{RRM} (100\%) = -1355 \text{ A}$   
 $t_{tr} = 0,21 \text{ }\mu\text{s}$



### Switching Definitions Buck

**figure 8. FWD**

**Turn-on Switching Waveforms & definition of  $t_{Qrr}$**   
( $t_{Qrr}$  = integrating time for  $Q_{rr}$ )

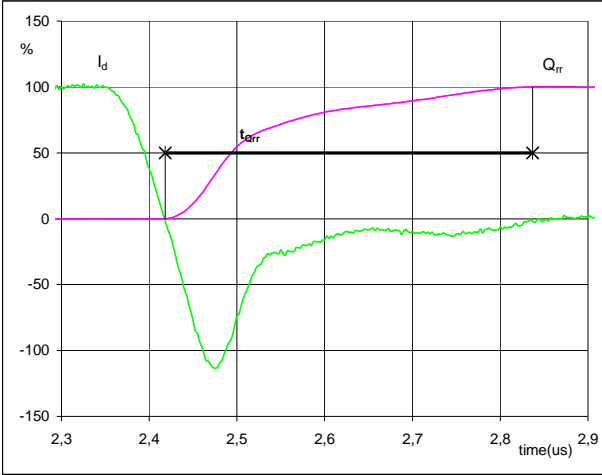

$I_d$ (100%) =	1201	A
$Q_{rr}$ (100%) =	136,71	$\mu\text{C}$
$t_{Qrr}$ =	0,42	$\mu\text{s}$

**figure 9. FWD**

**Turn-on Switching Waveforms & definition of  $t_{Erec}$**   
( $t_{Erec}$  = integrating time for  $E_{rec}$ )

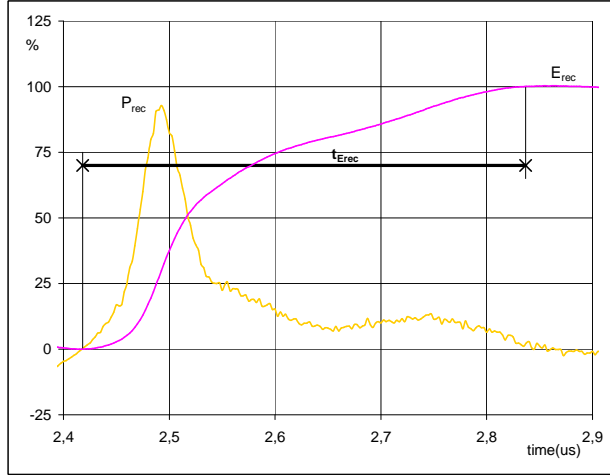

$P_{rec}$ (100%) =	720,80	kW
$E_{rec}$ (100%) =	61,41	mJ
$t_{Erec}$ =	0,42	$\mu\text{s}$



### Switching Definitions Boost

**General conditions**

$T_j$	=	125 °C
$R_{gon}$	=	0,42 Ω
$R_{goff}$	=	0,42 Ω

**figure 1. IGBT**

**Turn-off Switching Waveforms & definition of  $t_{doff}$   $t_{Eoff}$**   
( $t_{Eoff}$  = integrating time for  $E_{off}$ )

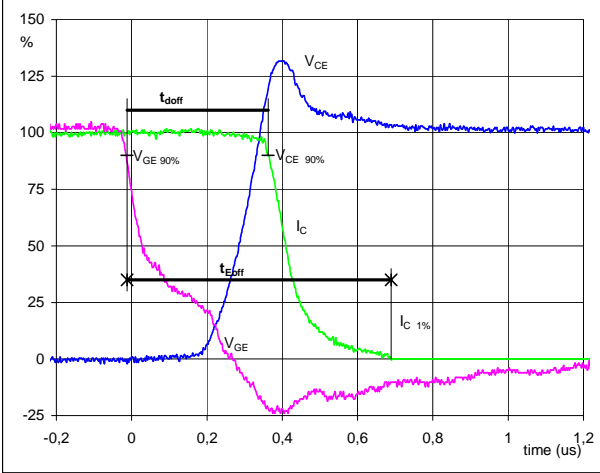

$V_{GE}$ (0%) =	-10	V
$V_{GE}$ (100%) =	15	V
$V_C$ (100%) =	600	V
$I_C$ (100%) =	1200	A
$t_{doff}$ =	0,34	μs
$t_{Eoff}$ =	0,70	μs

**figure 2. IGBT**

**Turn-on Switching Waveforms & definition of  $t_{donr}$   $t_{Eon}$**   
( $t_{Eon}$  = integrating time for  $E_{on}$ )

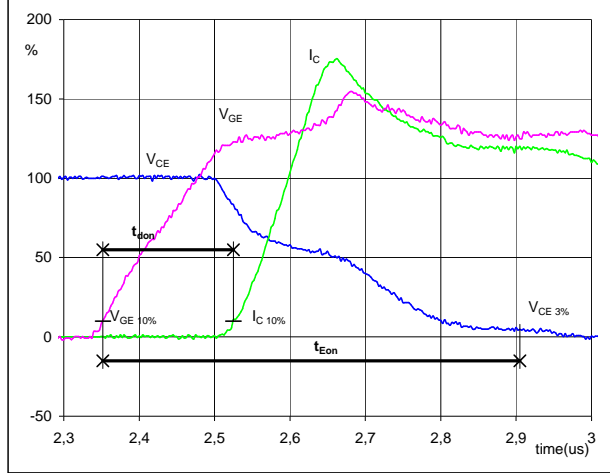

$V_{GE}$ (0%) =	-10	V
$V_{GE}$ (100%) =	15	V
$V_C$ (100%) =	600	V
$I_C$ (100%) =	1200	A
$t_{donr}$ =	0,17	μs
$t_{Eon}$ =	0,55	μs

**figure 3. IGBT**

**Turn-off Switching Waveforms & definition of  $t_f$**

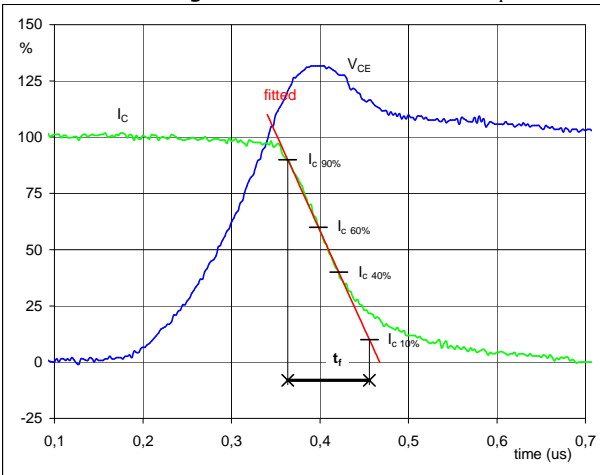

$V_C$ (100%) =	600	V
$I_C$ (100%) =	1200	A
$t_f$ =	0,092	μs

**figure 4. IGBT**

**Turn-on Switching Waveforms & definition of  $t_r$**

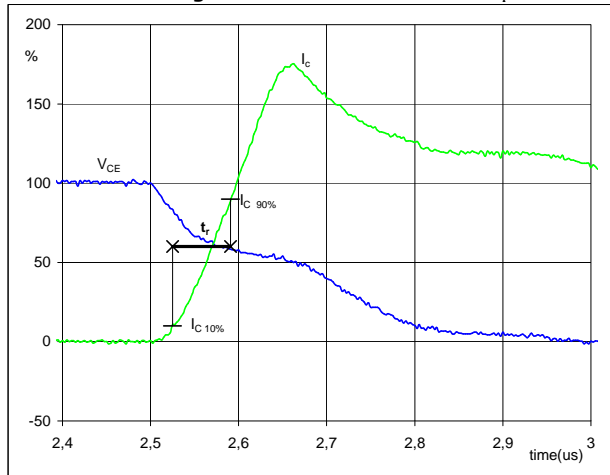

$V_C$ (100%) =	600	V
$I_C$ (100%) =	1200	A
$t_r$ =	0,065	μs



### Switching Definitions Boost

**figure 5. IGBT**  
**Turn-off Switching Waveforms & definition of  $t_{Eoff}$**

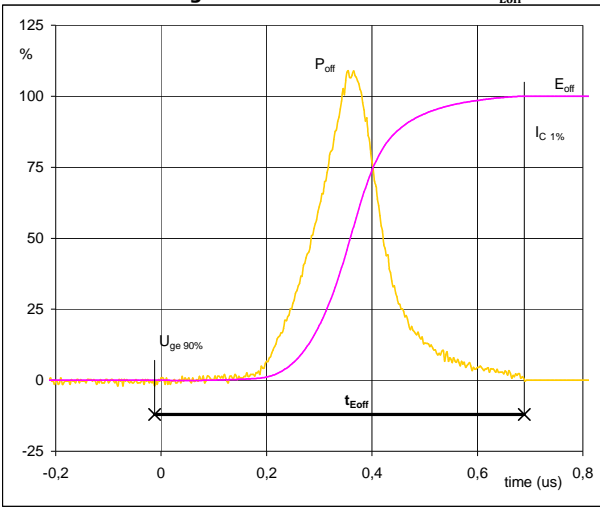

$P_{off} (100\%) = 719,72 \text{ kW}$   
 $E_{off} (100\%) = 119,96 \text{ mJ}$   
 $t_{Eoff} = 0,70 \text{ } \mu\text{s}$

**figure 6. IGBT**  
**Turn-on Switching Waveforms & definition of  $t_{Eon}$**

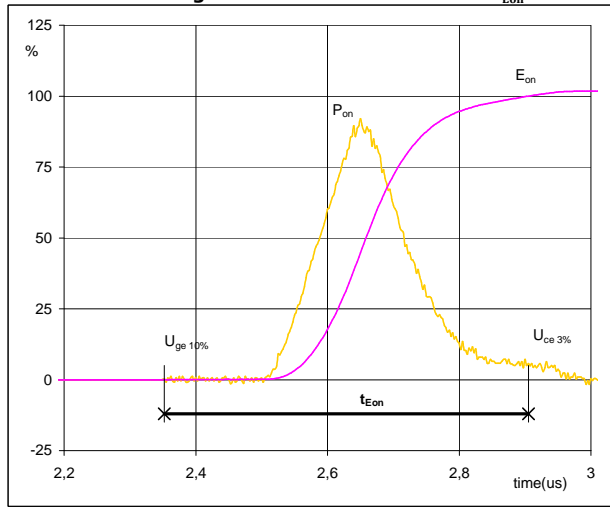

$P_{on} (100\%) = 719,724 \text{ kW}$   
 $E_{on} (100\%) = 104,74 \text{ mJ}$   
 $t_{Eon} = 0,55 \text{ } \mu\text{s}$

**figure 7. FWD**  
**Turn-off Switching Waveforms & definition of  $t_{rr}$**

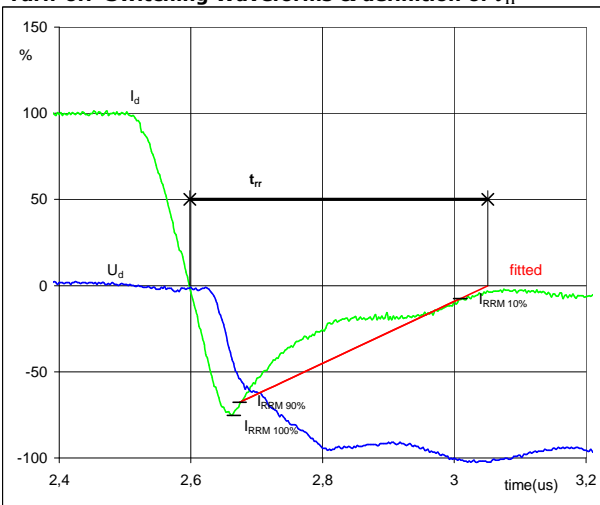

$V_d (100\%) = 600 \text{ V}$   
 $I_d (100\%) = 1200 \text{ A}$   
 $I_{RRM} (100\%) = -903 \text{ A}$   
 $t_{rr} = 0,45 \text{ } \mu\text{s}$





### Switching Definitions Boost

**figure 8.** FWD  
**Turn-on Switching Waveforms & definition of  $t_{Qrr}$**   
( $t_{Qrr}$  = integrating time for  $Q_{rr}$ )

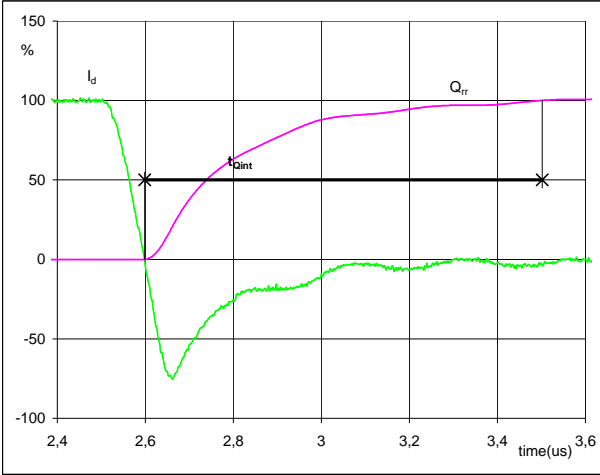

$I_d$ (100%) =	1200	A
$Q_{rr}$ (100%) =	172,55	$\mu\text{C}$
$t_{Qint}$ =	0,90	$\mu\text{s}$

**figure 9.** FWD  
**Turn-on Switching Waveforms & definition of  $t_{Erec}$**   
( $t_{Erec}$  = integrating time for  $E_{rec}$ )

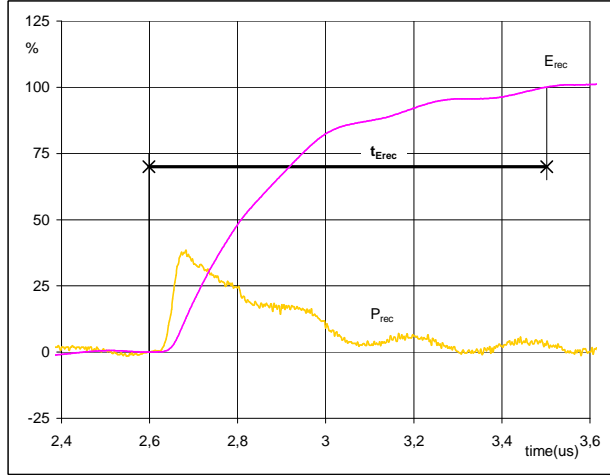

$P_{rec}$ (100%) =	719,72	kW
$E_{rec}$ (100%) =	69,81	mJ
$t_{Erec}$ =	0,90	$\mu\text{s}$



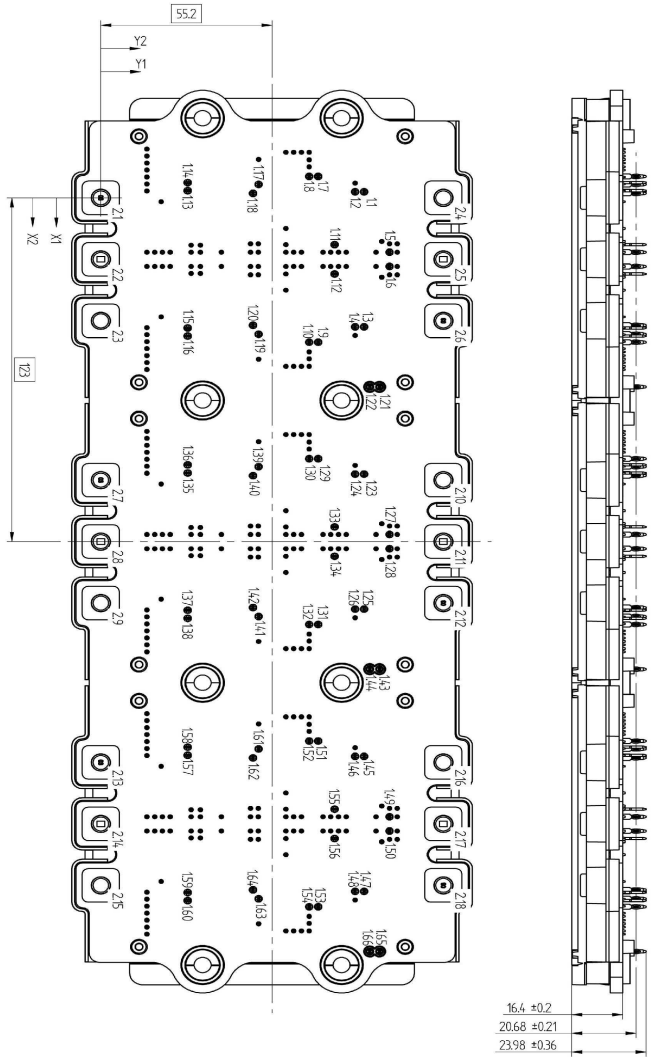

Outline							
Driver pins				Low current connections			
Pin	X1	Y1	Function	M6 screw	X2	Y2	Function
1.1	-2,15	84,85	G11-1				
1.2	-2,15	81,95	E11-1	2.1	0	0	PH
1.3	46,15	84,85	G13-2	2.2	22	0	PH
1.4	46,15	81,95	E13-2	2.3	44	0	PH
1.5	19,45	93,05	DC+desat	2.4	0	110,4	DC+
1.6	24,55	93,05	DC+desat	2.5	22	110,4	GND
1.7	-7,65	70,05	G13-1	2.6	44	110,4	DC-
1.8	-7,65	67,15	E13-1	2.7	101	0	PH
1.9	51,65	70,05	G13-2	2.8	123	0	PH
1.10	51,65	67,15	E13-2	2.9	145	0	PH
1.11	16,75	75,35	GND_desat	2.10	101	110,4	DC+
1.12	27,25	75,35	GND_desat	2.11	123	110,4	GND
1.13	-2,55	28	G14-1	2.12	145	110,4	DC-
1.14	-5,45	28	E14-1	2.13	202	0	PH
1.15	46,55	28	G14-2	2.14	224	0	PH
1.16	49,45	28	E14-2	2.15	246	0	PH
1.17	-4,8	50,85	G12-1	2.16	202	110,4	DC+
1.18	-1,6	49,05	E12-1	2.17	224	110,4	GND
1.19	48,8	50,85	G12-2	2.18	246	110,4	DC-
1.20	45,6	49,05	E12-2				
1.21	67,65	89,8	Therm1-1				
1.22	67,65	86,7	Therm2-1				
1.23	98,85	84,85	G11-3				
1.24	98,85	81,95	E11-3				
1.25	147,15	84,85	G13-4				
1.26	147,15	81,95	E13-4				
1.27	120,45	93,05	DC+desat				
1.28	125,55	93,05	DC+desat				
1.29	93,35	70,05	G13-3				
1.30	93,35	67,15	E13-3				
1.31	152,65	70,05	G13-4				
1.32	152,65	67,15	E13-4				
1.33	117,75	75,35	GND_desat				
1.34	128,25	75,35	GND_desat				
1.35	98,45	28	G14-3				
1.36	95,55	28	E14-3				
1.37	147,55	28	G14-4				
1.38	150,45	28	E14-4				
1.39	96,2	50,85	G12-3				
1.40	99,4	49,05	E12-3				
1.41	149,8	50,85	G12-4				
1.42	146,6	49,05	E12-4				
1.43	168,65	89,8	Therm1-2				
1.44	168,65	86,7	Therm2-2				
1.45	199,85	84,85	G11-5				
1.46	199,85	81,95	E11-5				
1.47	248,15	84,85	G13-6				
1.48	248,15	81,95	E13-6				
1.49	221,45	93,05	DC+desat				
1.50	226,55	93,05	DC+desat				
1.51	194,35	70,05	G13-5				
1.52	194,35	67,15	E13-5				
1.53	253,65	70,05	G13-6				
1.54	253,65	67,15	E13-6				
1.55	218,75	75,35	GND_desat				
1.56	229,25	75,35	GND_desat				
1.57	199,45	28	G14-5				
1.58	196,55	28	E14-5				
1.59	248,55	28	G14-6				
1.60	251,45	28	E14-6				
1.61	197,2	50,85	G12-5	1.64	247,6	49,05	E12-6
1.62	200,4	49,05	E12-5	1.65	269,7	89,8	Therm1-3
1.63	250,8	50,85	G12-6	1.66	269,7	86,7	Therm2-3





Vincotech

## Ordering Code and Marking - Outline - Pinout

Version				in DataMatrix as			
Standard				70-W624N3A1K2SC-L400FP			
Standard with thermal paste				70-W624N3A1K2SC-L400FP-/3/			
 Name Date code Lot Serial Vincotech UL	Text	Name		Date code	UL & Vinco	Lot	Serial
		NN-NNNNNNNNNNNNNN-NNNNNNNN		WWYY	UL VIN	LLLLL	SSSS
 Name Date code Lot Serial Vincotech UL	Datamatrix	Type&Ver	Lot number	Serial	Date code		
		TTT-TTT	LLLLL	SSSS	WWYY		

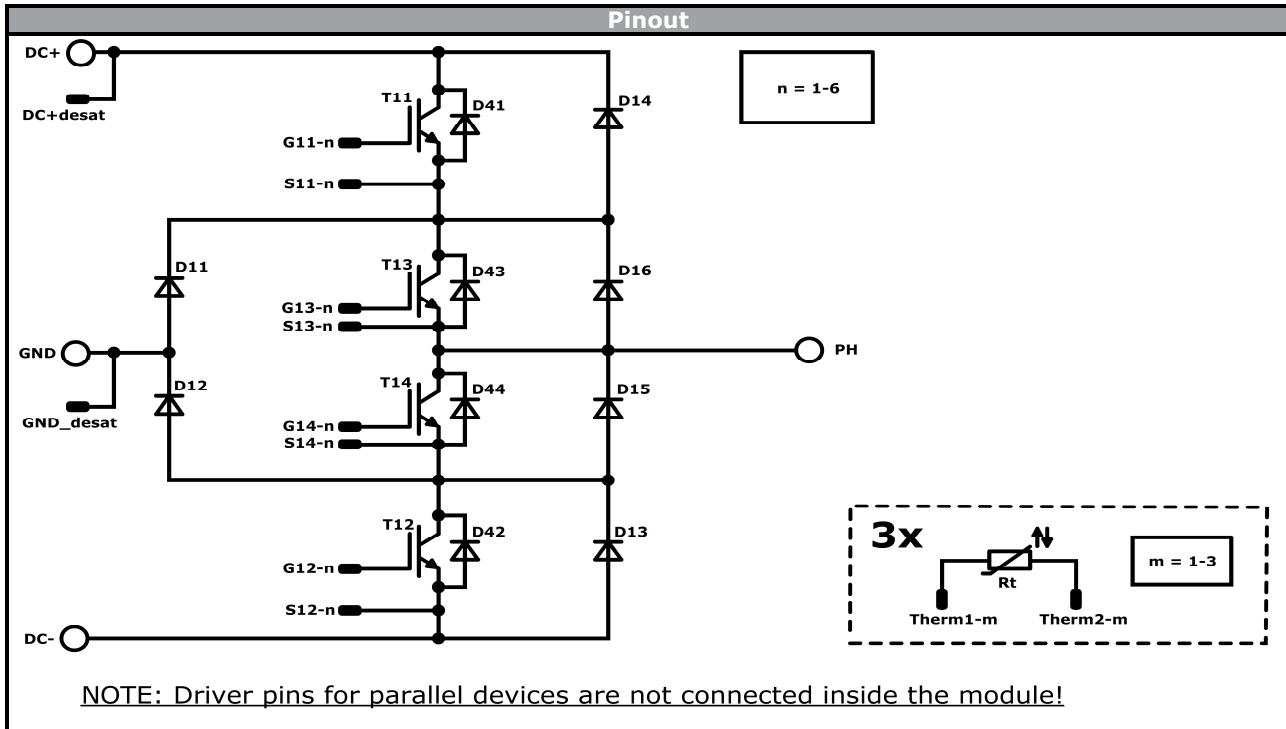

Identification						
ID	Component	Voltage	Current	Function	Comment	
T11, T12	IGBT	1200 V	1200 A	Buck Switch		
D11, D12	FWD	1200 V	1200 A	Buck Diode		
T13, T14	IGBT	1200 V	1200 A	Boost Switch		
D13, D14	FWD	1200 V	900 A	Boost Diode		
D15, D16	FWD	1200 V	900 A	Boost Inverse Diode		
D41, D42	FWD	1200 V	90 A	Buck sw. Prot. Diode		
D43, D44	FWD	1200 V	90 A	Boost sw. Prot. Diode		
Rt	NTC			Thermistor		



Packaging instruction			
Standard packaging quantity (SPQ)	<b>4</b>	>SPQ Standard	<SPQ Sample

Handling instruction
Handling instructions for VINco X12 packages see vincotech.com website.

Package data
Package data for VINco X12 packages see vincotech.com website.

Document No.:	Date:	Modification:	Pages
70-W624N3A1K2SC-L400FP-D2-14	08 Sep. 2017		

**DISCLAIMER**

The information, specifications, procedures, methods and recommendations herein (together "information") are presented by Vincotech to reader in good faith, are believed to be accurate and reliable, but may well be incomplete and/or not applicable to all conditions or situations that may exist or occur. Vincotech reserves the right to make any changes without further notice to any products to improve reliability, function or design. No representation, guarantee or warranty is made to reader as to the accuracy, reliability or completeness of said information or that the application or use of any of the same will avoid hazards, accidents, losses, damages or injury of any kind to persons or property or that the same will not infringe third parties rights or give desired results. It is reader's sole responsibility to test and determine the suitability of the information and the product for reader's intended use.

**LIFE SUPPORT POLICY**

Vincotech products are not authorised for use as critical components in life support devices or systems without the express written approval of Vincotech.

As used herein:

1. Life support devices or systems are devices or systems which, (a) are intended for surgical implant into the body, or (b) support or sustain life, or (c) whose failure to perform when properly used in accordance with instructions for use provided in labelling can be reasonably expected to result in significant injury to the user.
2. A critical component is any component of a life support device or system whose failure to perform can be reasonably expected to cause the failure of the life support device or system, or to affect its safety or effectiveness.